

Single Stage Reverse Osmosis Controller

Operation Manual

V1.1

1 General

The Single Stage Reverse Osmosis Controller adds new functional options and add the high/low pressure flushing options for controlling the running process. $0.1/1.0/10.0 \text{ (cm}^{-1}\text{)}$ three conductance cells are added for conductivity measurements to make the measurement range (low conductance $(0.1\sim 200)\mu\text{S/cm}$ and high conductance $(5\sim 9999)\mu\text{S/cm}$) to be greatly extended. It is especially suitable for raw water with better water or bitter and brackish water in high conductivity area, and all this does not require complex interface menu settings, only can be obtained by hand in the rear terminal wiring..

In view of the global customer for the engineering habits, the controller has conductivity ($\mu\text{S/cm}$), total dissolved solids (ppm) engineering units for selection, you can select through the rear terminals 17 to 19 wiring.

2 Process Flow Selections

The controller also applies to the following two typical single stage RO work modes:

- A. Raw water tank in front of pipeline with larger changes in water supply .
- B. Direct connection with tap water supply which pipelines with relatively stable water supply

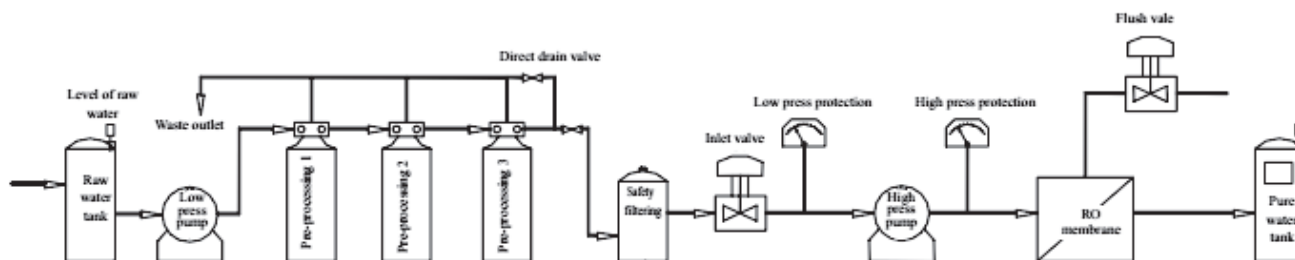

Fig. 1-A First level RO process flow with raw water tank

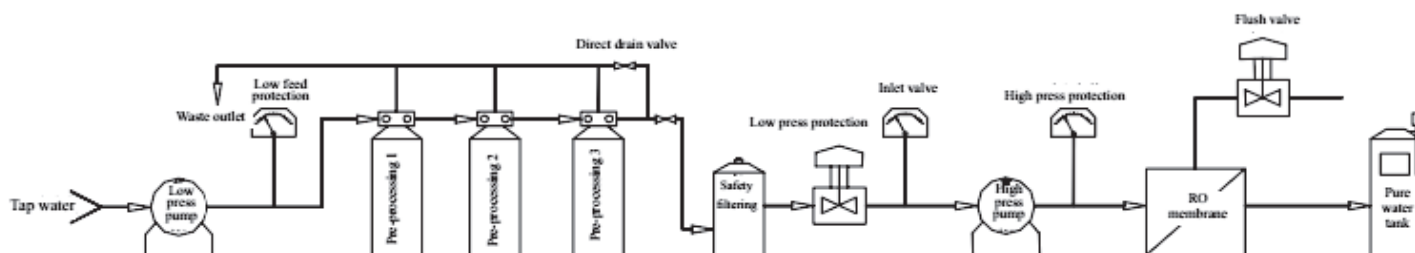

Fig. 1-B First level RO process flow with direct water supply

3 Functions and Main Technical Specification

1. Low feed protection

In case of water supply pressure is too low/the front water tank level is too low, the pressure switch trigger controller will pause the RO system running, the“LOW FEED PRESS”lamp will be lightened, the screen will display “ALA” and the buzzer will give an alarm. After that, the controller will keep detecting the low feed switch. When the water supply or water level is resumed, the system will be restarted.

2. Low pressure protection

In case that the pre-processing is in flushing or softening tank is in regeneration or security filter is dirty and plugging, the RO system can not be provided the normal water supply pressure, that is insufficient pressure, the “LOW PRESS” lamp will be lightened, the screen will display “ALA” and the buzzer will give an alarm, the controller will shut down the whole RO system to realize automatic protection.

After that, the controller will continuously inspect low pressure protection, RO control system tries to start up for the first time after pressure recovery delays for 1 minute. After start-up, if the water supply can meet the continuous working conditions of RO system and the system continues to run. If the low pressure protection appears again, the above operation is repeated.

The program is limited to try three times. If the start-up fails for three times, the system will come into a dead-lock status. The low press light always maintains diagnosis status and indicates downtowns reason. Press the reset key to exit and then restart after handling.

3. High pressure protection

It is limited to be used in high pressure protection system. In case of high pressure over limit, the “HIGH PRESS” lamp will be lightened, the screen will display “ALA” and the buzzer will give an alarm, the controller will shut down the whole RO system and wait for the elimination of high pressure.

When the high pressure eliminates, the controller will try to start up for the first time after 1 minute. If the outlet pressure meets the setting pressure range, the controller continues to run, otherwise, enters the protection status again.

This program is limited to try three times. If the start-up fails for three times, the system will come into a dead-lock status and keep in the diagnosis of trigger status, the processing method is the same with low pressure protection.

4. Conductivity limit alarm

When the water conductivity value is over limit during the initial commissioning or operating period, the “HIGH” lamp on the panel will be lightened, the buzzer will give an alarm, and the control bypasses will switch on (this electromagnetic valve is installed on low position) for discharging. When the water conductivity falls below the limit, the alarm will be set off, the bypass valve will shut down later, and the producing water flows to pure water tank.

5. Pure water tank level control

When the water tank level is less than the lower level, the system will immediately start the RO system to produce water, and automatically transfer to stop until the pure water tank level reaches the high level limit. Before shutdown, the system will be flushing according to the set film flushing time. After that, the system will automatically turn into standby status.

6. Timing membrane flush

The controller programs set three patterns, that is, flushing each startup and shut down, interval flushing for continuous operation timeout, long standby flushing. The flushing time setting is given. The flushing time are all open settings in the menu (the items that do not need to flushing, the time is set to zero, that is giving up).

7. External control switch (system cascade)

With the front-end preprocessing chain contact (normally open), the system automatically runs after contact closure.

If you don't use this function, back connect terminal 7 and 8 can be short connected (see the wiring diagram in figure 4 and figure 5).

4 Main technical specifications:

Measuring range (describe by conductivity)	0.1cm ⁻¹	1.0cm ⁻¹	10.0cm ⁻¹
	(0.1~200) μS/cm	(1~2000) μS/cm	(10~9999) μS/cm
Power Voltage	AC 220V ±15% 50Hz		
Power consumption	≤10W		
Environment conditions	temperature: (5~45) °C; humidity: ≤85%RH		
Accuracy	1.5 level		
Load capacity of output contact	3A/250V AC (the magnetic valve should be driven through intermediate relay to get a more permanent electrical reliability)		
Operation pressure of conductance cell	≤0.5MPa		
Medium temperature	(5~50) °C		
Temperature compensation	Automatic temperature with 25°C as reference temperature		
Distance of measuring range	≤30m (standard cable length 5 meters; or specify before ordering)		
Display mode	3½ digit 0.6inch LED digital display		
Electrode selected	Standard 1.0cm ⁻¹ , optional 0.1/10.0 (cm ⁻¹) agreed when placing order		
Outline dimensions	96×96×130mm (height×width×depth)		
Hole size	91×91mm (height×width)		

5 Front Panel Illustration

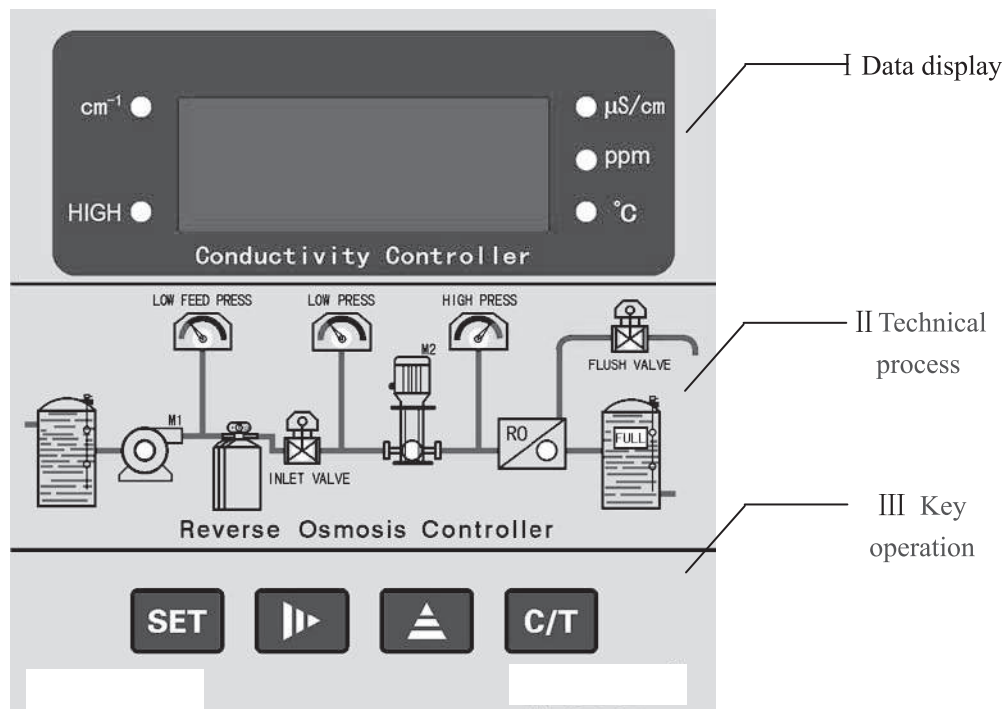











Fig.2 Front panel

Fig.1:

The display board is shown in the above figure, there are three areas from up to down: I, II and III.	
	5 LED status indicator lamps and conductivity value display area:

I Data display	cm ⁻¹		The indicator light is flashing when set the precise numerical value of the conductivity constant.
	HIGH		Indication for conductivity over limit alarm
	μS/cm		conductivity value, representing that the displayed value is the conductivity value of the produced water
	ppm		TDS indicator light, representing that the displayed value is the total dissolved solids of the produced water
	°C		Temperature value of the fluid, representing that the displayed value is the temperature value of the current fluid
	Normal display	Status light	Display code meaning
			The current display unit μ S/cm, the figure value 200 μ S/cm
			The current display unit ppm, the figure value 100ppm
			The current display unit is water temperature, the figure value 25.3°C
	Abnormal state display code		Display code meaning
	When display ()		ECS is not switched on and system is in the standby status
	When display ()		Water tank is full and the “FULL” lamp will be lightened
	When display ()		“ALARM” lamp will be lightened when alarm appears
II Technical process	The indication of RO system operation status, which contains 9 LED indicator lamps, and the lamps respectively indicate:		
	LOW FEED PRESS	Indicator lamp for low feed alarm, indicating that there is no water in the raw water tank or the water is not sufficient.	
	LOW PRESS	Indication for inlet water operation of high pressure pump indicating that the inlet water operation pressure of high pressure pump is too low.	
	HIGH PRESS	Indication for over pressure operation of high pressure pump, indicating that the outlet pressure of high pressure pump is too high	
	INLET VALVE	Indication for inlet magnetic valve turning on, indicating that the inlet magnetic valve is turned on.	
	M1	Indication for raw water pump operation, indicating that the raw water pump is switched on.	
	M2	Indication for high pressure pump operation, indicating that the high pressure pump is switched on	
	RO	Indication for water producing status, indicating that the RO system is in water producing operation.	
	FLUSH VALVE	Indication for flush magnetic valve turning on, indicating that the flush magnetic valve is turned on.	
	FULL	Indication for full pure water tank, indicating that the water level in the pure water tank has reached the high limit	

III Key operation	Setting and operation keys, their meanings are	
		Parameter setting key, select the parameter items to be modified or inquired.
		Circularly select thousand, hundred, ten and unit digit, the selected digit flashes.
		Adjust the number of the selected digit (circle from 0 to 9).
		Confirm to save the modified parameter in parameter modification or switch between the indication value of conductivity and temperature in measuring status

6 Setting procedure

a When the instrument is powered on, turn on the external control switch to start the water, and the digital window shows the current conductivity value.

b Long-time press button, it will appear single cycle in the following series of menus, use , and keys to modify or set the menu item by item.

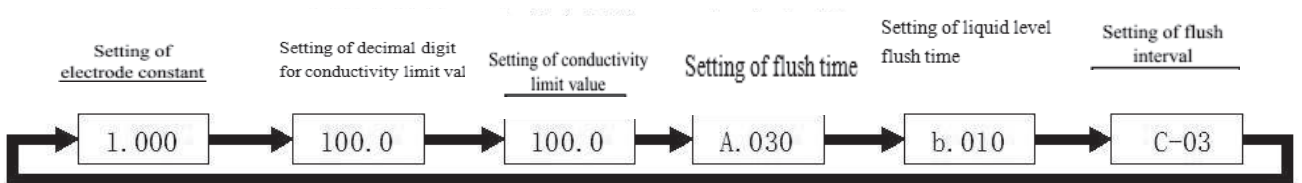

Fig.3 Setting procedure

Fig.2:

Setting item	Display content	Notes	
Constant		0.1 (cm-1) Constant level	Display data X10=constant vaue
		1.0 (cm-1) Constant level	Display data X1=constant vaue
		10.0 (cm-1) Constant level	Display data X0.1=constan vaue
Decimal point position setting for conductivity limit value		Select decimal point position of conductivity limit value	
Conductivity over limit setting		Set the conductivity over limit value.	
Start-up flushing time setting		Factory default 30S, range can be set 0~249 seconds.	
Liquid level flushing time setting		Factory default 10S, range can be set 0~249 seconds	
Flushing interval setting		Factory default 3h, range can be set 0~99h.	

The above interface parameter changes need to be combined with , , keys. Press

key to save data and back to measuring state when data modification is completed (if you do not press **C/T** key, the interface will be back to measuring state after three minutes, and the modification will not be saved.).

7 Rear panel illustration

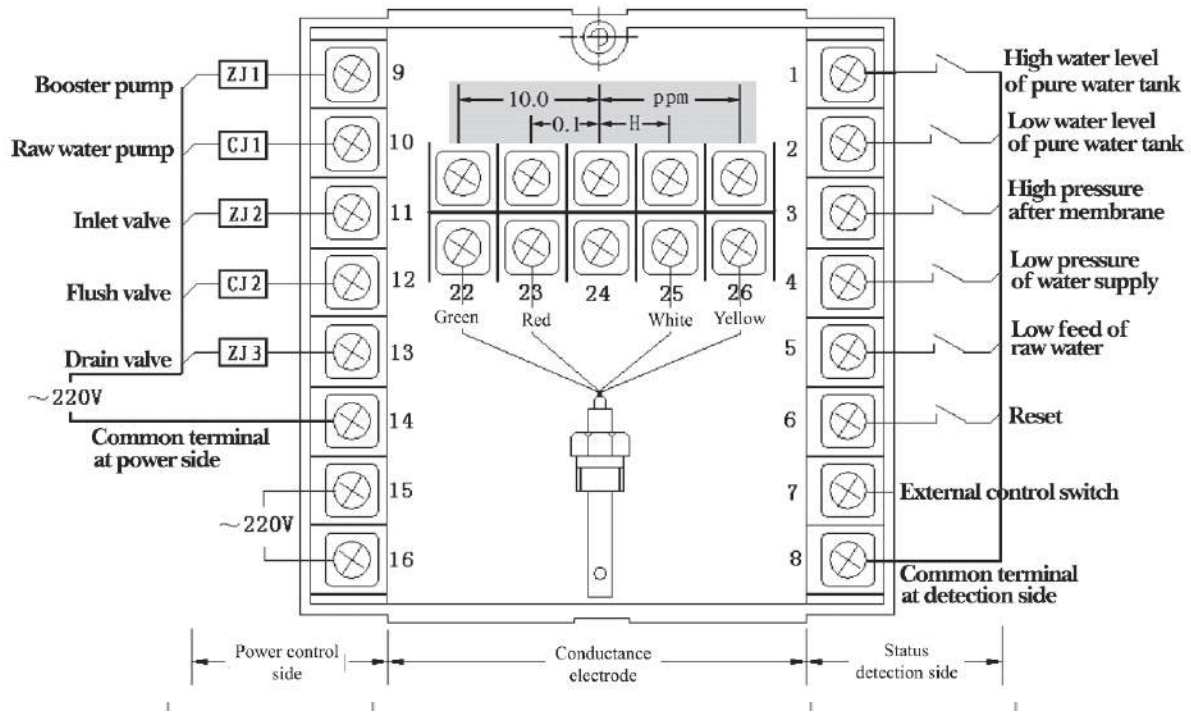

Fig.4 Rear panel

Rear panel connection truth table is as follows (figure 3):

Function option	Options	17	18	19	20	21
Raw water conductance cell	Default 1.0(cm ⁻¹)conductance cell	×	×	COM	—	—
	Select 10.0(cm ⁻¹)conductance cell	√	×			
Water conductance cell	Default 1.0(cm ⁻¹)conductance cell	×	×			
	Select 0.1 (cm ⁻¹) conductance cell	×	√			
Flushing mode	The low pressure flushing by default	—	—		×	—
	Select the high pressure flushing				√	
Engineering unit	The default conductivity (μS/cm)	—	—	—	×	
	Select TDS (ppm)				√	

【notes】 √: connect with COM; ×: disconnect with COM; —: irrelevant item)

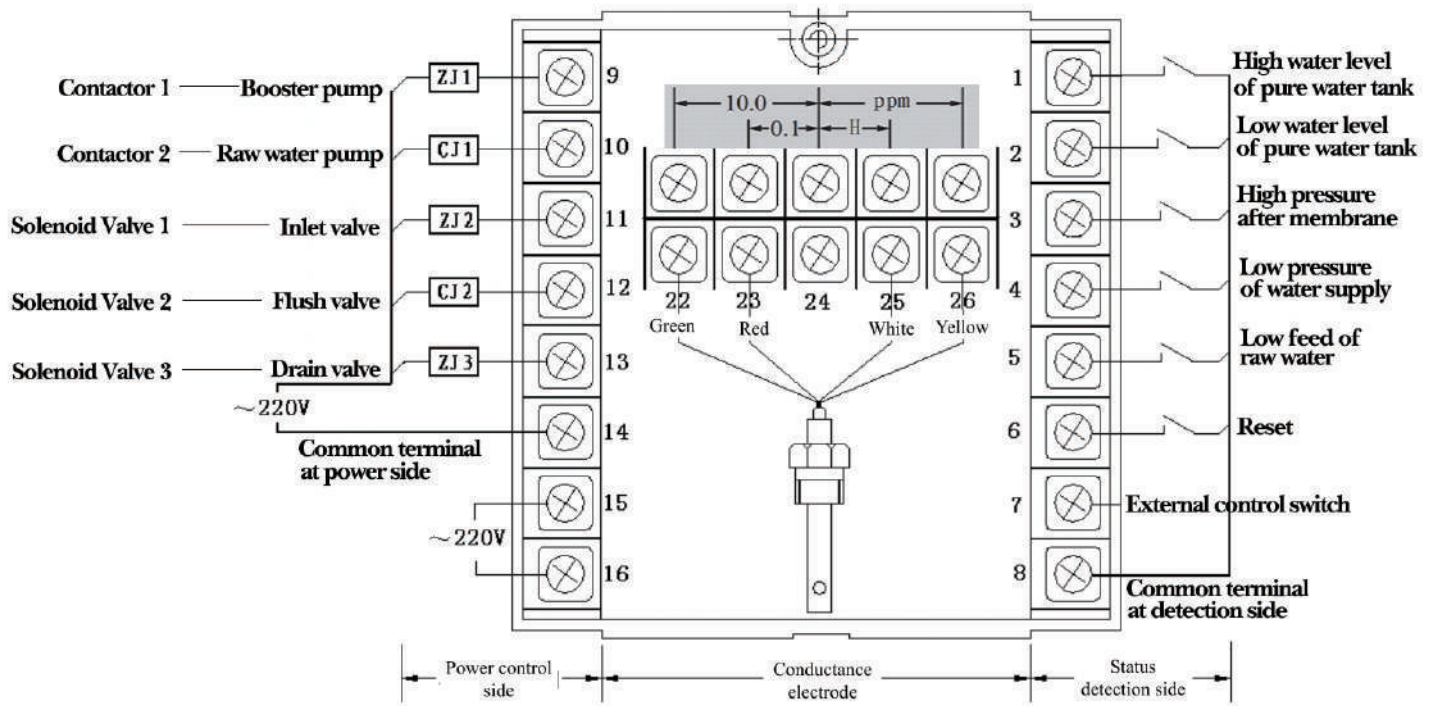

Fig.5 Rear panel connection diagram (Direct driving and small load)

Since small relay is used in the controller, when driving larger inductive load, intermediate relay or contractor must be used, so as to prolong the service life of signal relay and to reduce failure. direct driving is not allowed.

Note: ZJ—intermediate relay CJ—magnetic contactor (refer to appendix for type selection)

8 Electric control circuit diagram (for reference)

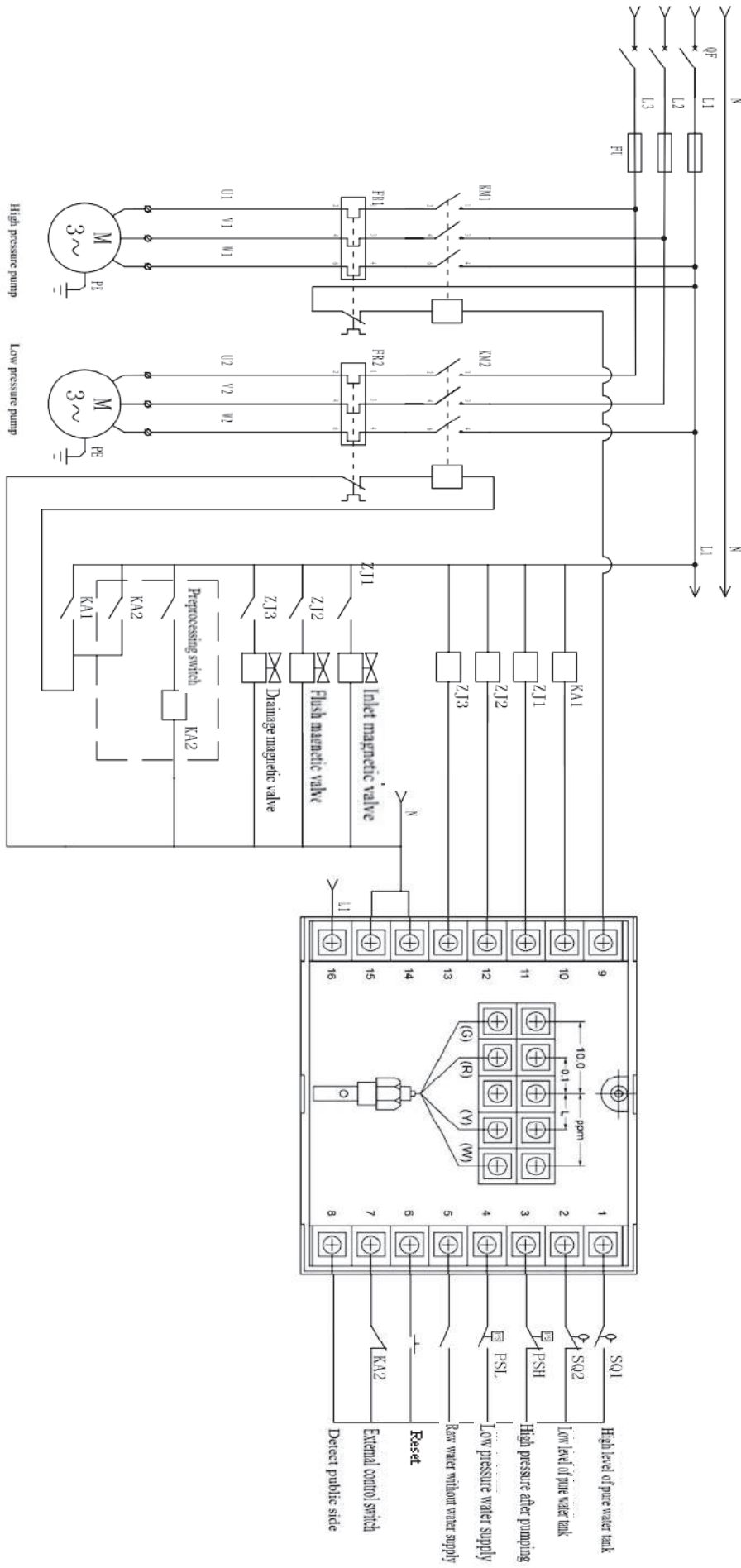
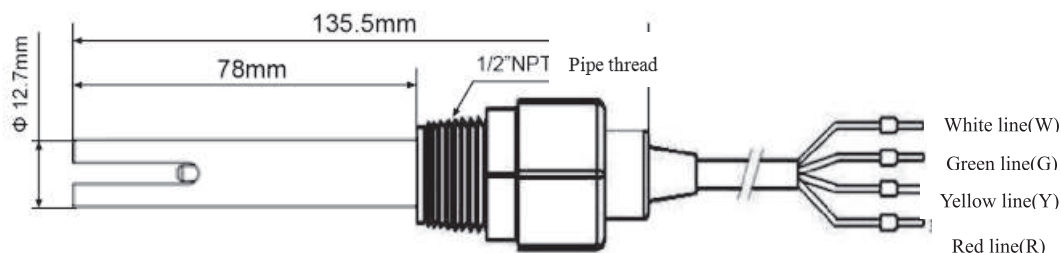

Fig 6 Electric control circuit diagram (The expansion of the ability to drive the larger contactor)

9 Measurement electrode (CELL) installation

1. CELL external dimension and installation method



Pipe thread White line

Fig.7 $C=1.0$ (cm^{-1}) CON1134-13 Plastic CELL external dimension

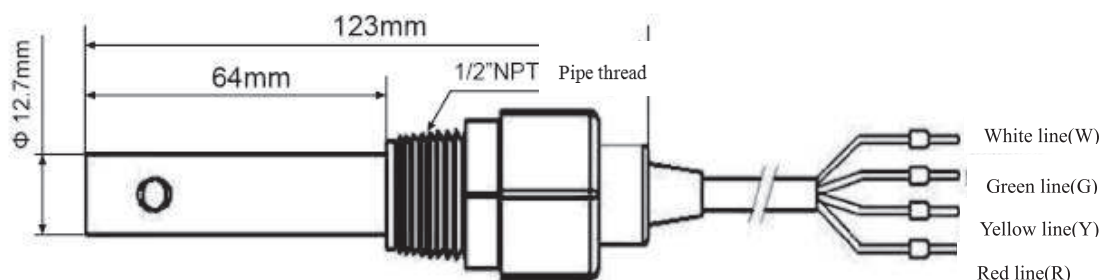

Fig.8 $C=0.1$ (cm^{-1}) CON3133-13 Stainless steel CELL external dimension

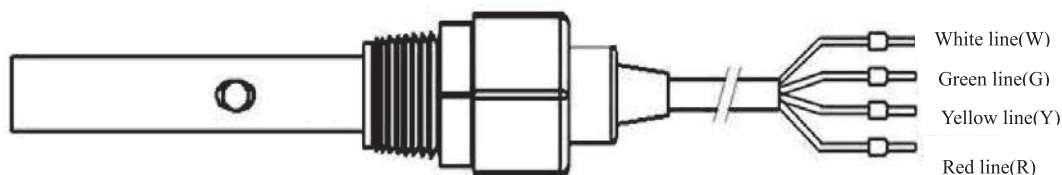

Fig.9 $C=10.0$ (cm^{-1}) CON2136-13 graphite CELL external dimension

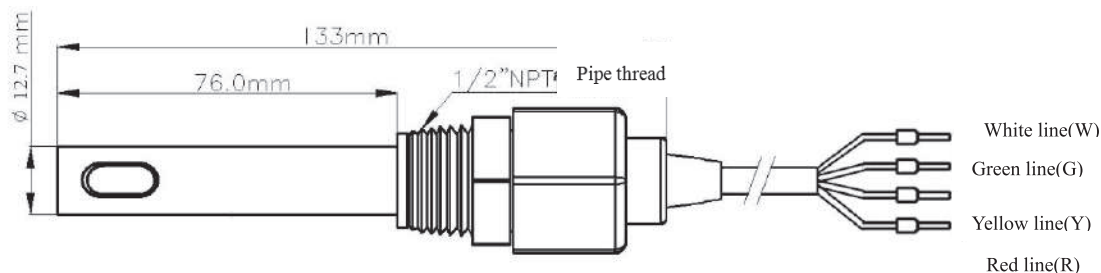

Fig.10 $C=1.0$ (cm^{-1}) CON2134-13 The graphite CELL external dimension

2. Common installation problems

Cell should be carefully installed. Incorrect installation cannot get satisfaction measurement data. Please carefully choose installation position and weigh the installation type, so as to avoid the distortion of measurement data.

1) Insertion depth:

Figure A cell installation mount is too long, waist hole is in static area, the cell is easy to form dead cavity and measuring error is larger. Short installation mount should be used according to the figure B to make

the waist hole in water active region.

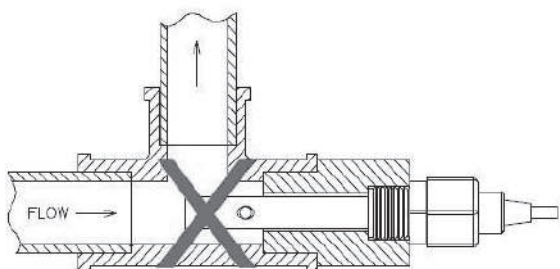

Fig. A Wrong installation

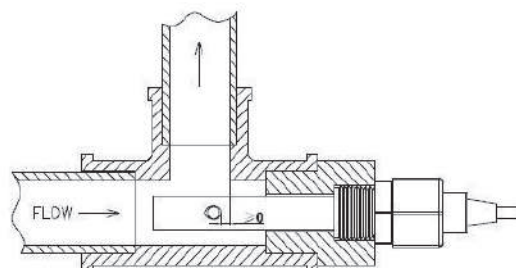

Fig. B The correct installation

2) Fig. A waist hole is in dead cavity, which will cause big and unstable measurement error., it should be installed according to the figure B.

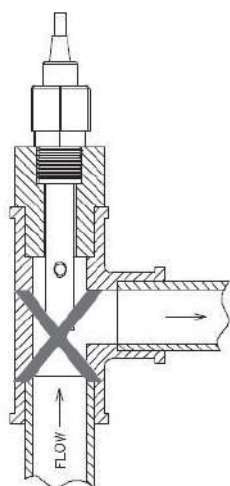

Fig. A Wrong installation

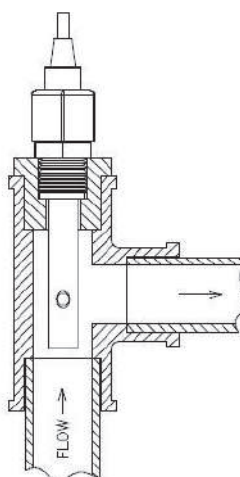
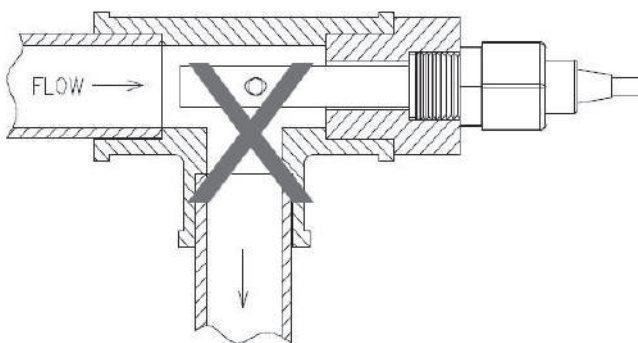

Fig. B The correct installation is that the small round hole is in the water window

3) Other common wrong installation



This installation is not recommended. Downward flow cannot guarantee the tee tube full or high accumulation gas will cause instable measurement error value.

3. Notes on the installation and maintenance

1) Conductance cell should be installed in the place where the pipeline flow is stable and no bubbles. By-pass flow installation can be adopted to avoid inaccurate measurement.

2) For all installation sides of the coaxial conductance cell, the front should be toward the Flow

direction and deep into the flowing water. When conductance cells with other structural shapes are installed in lateral side, please prevent the air pressure produced by turbulence in measuring room causing the measurement data disorder.

3) The measuring signal is a weak electrical signal. So cable collecting must be run independently, it is prohibited to connect, wear tube together and band with the same group of cable connectors or terminal board, so as to avoid interference measurement or breakdown of measurement unit.

4) The cable of the preconducting conductance cell is the standard length and special cable. When the measuring cable is lengthened, please contact the manufacturer before delivery.

5) Please keep the measuring part of the conductance cell clean during installation. Do not directly touch the surface with your hand or unclean objects. The accurate data can not be measured in a very long time if you touch grease and plastic objects.

6) The conductance cell, as a sophisticated component, can not be disassembled. The shape and size can not be changed. It also can not be washed, immersed with strong acid and alkali or scratched by machine. All these actions will lead to constant change and affect the measurement accuracy of the system.

7) The measurement cable is special cable and should not be changed at will or it will cause significant error.

8) The instrument adopts precision IC and electronic components assembly and should not be installed in direct sunlight. It should be placed in dry environment or in control box to avoid instrument leakage or measurement error caused by water splash or moisture.

9) In order to ensure the safety of installation, switching on the power after installation to detect.

【warning】 Applied in the field of food, beverage and health. Platinum plating black plastic conductance cell is not recommended. It does not meet the requirements of health level conductance cell.

10 Trouble shooting

- 1) The magnetic valve can not be opened ---filter mesh in front of the valve loses efficiency or quality problem of magnetic valve.
- 2) Low pressure alarm when flush valve is opened---The security filter is dirty or insufficient water pressure, which can not provide a normal water supply pressure to the RO system.
- 3) Other phenomenon, analysis and treatment according to the actual situation.

11 Complete sets of instrument

Name	Model	Quantity	Unit
controller	Single Stage Reverse Osmosis Controller	1	set
Fixing clamp	Metal	1	set
Conductance cell	(0.1/1.0/10.0) cm^{-1}	1	quantity
Operation Manual	Printed Media	1	quantity

【note】: Factory default (10.0/1.0/0.1) cm^{-1} cable length 5meters,otherwise agreed for long cables when you order it.

12 Appendix

Appendix: Recommended when using the following data, please select the corresponding electrical

contactor.

Producing pure water flow (m ³ /h)	Raw water (pretreatment) flow (m ³ /h)	Membrane count(quantity)		The original water pump configuration		Ro booster pump power			
		4040 membrane	8040m membrane	The original water pump power (KW)	contactor (A)	Low pressure membrane 1.05MPa (KW)	Contact or (A)	High pressure membrane 1.55MPa (KW)	Contact or (A)
0.25	0.5	1		0.37	10	0.37	10	0.5	10
0.5	1	2		0.37~0.75	10	0.5~1.5	10	2.2	10
0.75	1.5	3		0.37~0.75	10	1.5	10	2.2	10
1	2	4		0.37~1.1	10	1.5	10	2.2	10
1.5	3	6		0.55~1.1	10	2.2	10	4	10
2	3.3	8		0.55~1.1	10	3	10	4	10
2.5	4	10		0.55~1.5	10	3	10	4	10
3	4.3	12		0.55~1.5	10	3	10	4	10
4	6.6	16		1.1~1.5	10	4	10	5.5	20
5	8	20		1.1~2.2	10	5.5	20	7.5	20
6	10		6	1.1~2.2	10	5.5	20	7.5	20
8	13		8	2.2~4	10	11	40	11	40
10	17		10	2.2~5.5	10~20	11	40	15	40
15	21		15	4~7.5	10~20	11	40	15	40
20	28		20	4~11	20~40				